

Article number: 2310431053  
Description: E+G Levelling elements  
LX.30-SW17-M6X32

## Measures

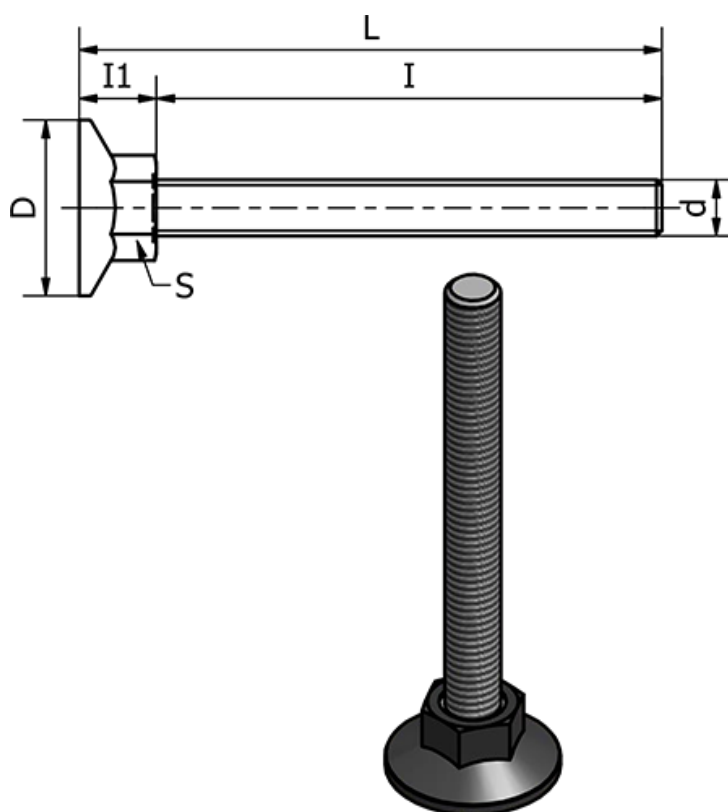

d	= M6
D	= 30
I	= 32
I1	= 12
L	= 44
S	= 17
Static load in (N)	= 1500
Type	= Forzinket

Weight (g) = -